

KENT
Ultra Violet
Water Purifiers
HOUSE of PURITY



SERVICE

To request for service 24x7, download KENT Service App by scanning the QR code or by giving a missed call: 9212252852

To speak to customer care executive call: 92-789-12345



Innovations for Better Living

Marketed by:
KENT RO SYSTEMS LTD.
E-6, 7 & 8, Sector-59, Noida, U.P.-201 309, India.
E-mail: sales@kent.co.in | Website: www.kent.co.in

Manufactured by:
KENT RO SYSTEMS LTD.
1) Khasra No. 93, Village-Bantakhedi, Tehsil-Roorkee, District-Haridwar, Uttarakhand-247 668, India.
2) A-6, Sector-87, Noida-201305, U.P., India.

For customer complaints, contact our Customer Care Officer at:
E-6, 7 & 8, Sector-59, Noida, U.P.-201 309, India. Call: 92-789-12345
E-mail: service@kent.co.in or visit us at www.kent.co.in

KENT Sterling UV

Under-the-counter UV Water Purifier
with a built-in hydrostatic tank

— Single Cabinet —

KENT
Ultra Violet
Water Purifiers
HOUSE of PURITY

Instructions Handbook



KENT TECHNOLOGY

UV + UF

Kent Deta Hai
Sabse Shudh Paani



Mineral RO™ and © 2005 KENT RO Systems Ltd.
The process & purifier is patented vide patent no. 199716.

Welcome to KENT

Dear Customer,

Welcome to the world of the KENT, leaders of water purification industry in India. With a KENT product, you have all the reasons to smile, because at KENT we take pride in the quality and laboratory-tested performance of our products.

We are confident that your decision to own **KENT Sterling UV Purifier** will go a long way in serving you with pure and mineral enriched drinking water, thus keeping you and your family in good health. We assure you that you will be satisfied with its trouble-free performance and quality which comes without any compromise.

This manual is an effort towards familiarising you with the operation and maintenance of **KENT Sterling UV Purifier**. Before operating the unit, please read it thoroughly and retain it for future reference. To ensure that the warranty of your water purifier is effective, fill up the enclosed warranty card and send the installation report within 15 days of purchase. Should you need further assistance, do not hesitate to contact your nearest KENT dealer or branch.

Best Wishes,

KENT RO SYSTEMS LTD.

Table of Contents

1.	KENT TECHNOLOGY - A Breakthrough in Water Purification	1
2.	Salient Features	1
3.	Items in the Box	2
4.	Important Instructions	2
5.	UV Process	3
6.	Automatic Operation	3
7.	UV Fail Alarm	3
8.	Water Flow Diagram	4
9.	Electrical Circuit Diagram	4
10.	Installation Instructions	5
11.	Recommended Site Preparations	5
12.	Starting-up the Purifier	6
13.	Maintenance	6
14.	Important Safety Instructions	7
15.	Warning	7
16.	Technical Specifications	8
17.	Testing Information	8

KENT TECHNOLOGY - A Breakthrough in Water Purification*

KENT proudly presents **KENT Sterling UV Purifier**. It is a new and advanced domestic water purifier which provides pure & healthy drinking water.

The futuristic **KENT Sterling UV Purifier**, developed at KENT Laboratory broadly comprises of state-of-the-art UV+UF double purification system. While the initial purification by UV deactivates bacteria and viruses, the double purification by the fine pores of the Hollow Fibre UF Membrane reduces them from the purified water. The Activated Carbon Pre-filter reduces bad taste and odour, so that the water you drink is healthy, safe and tasty.

Salient Features of KENT Sterling UV Purifier

- | | |
|---|---|
| <ol style="list-style-type: none"> 1. Compact single cabinet design for under-the-counter placement. 2. Double purification by UV + UF. 3. Fully automatic operation with auto-on/off. 4. Completely disinfects water without changing its taste, odour & pH scale. | <ol style="list-style-type: none"> 5. Suitable for tap water / municipal water supply. 6. Ideal for under-the-counter as well as side-by-side placement adjacent to refrigerator. 7. Effective against bacteria, viruses, and all kinds of residual impurities like chlorine |
|---|---|



Items in the Box

- | | |
|-------------------------------------|----------|
| 1. KENT Sterling UV Purifier | : 01 No. |
| 2. 3-Way Connector | : 01 No. |
| 3. S.S. Ball Valve | : 01 No. |
| 4. Faucet | : 01 No. |
| 5. Warranty Card | : 01 No. |
| 6. Food Grade Pipe 1/4" (White) | : 2.5 m |
| 7. Food Grade Pipe 3/8" (white) | : 2.5 m |

Important Instructions

<p style="font-size: small;">Avoid exposure to direct sunlight and installation in damp areas.</p>	<p style="font-size: small;">Make sure that the purifier is connected to normal temperature water supply only.</p>
<p style="font-size: small;">Maximum distance between the water source and purifier should not be more than 3 meters.</p>	<p style="font-size: small;">Avoid sharp bends in pipes.</p>
<p style="font-size: small;">In case of not using the purifier for more than two days, kindly switch off the power supply and drain out the storage tank.</p>	<p style="font-size: small;">To keep the storage tank clean, it should be drained once in 15 days.</p>
<p style="font-size: large; font-weight: bold;">KENT</p> <div style="border: 1px solid black; padding: 5px; display: inline-block; font-weight: bold;">GENUINE</div> <p style="font-size: small; font-weight: bold;">SPARE PARTS</p> <p style="font-size: x-small;">Use Genuine KENT spares for optimum performance.</p>	<p style="font-size: small;">Do not try to service the purifier on your own. Instead, call service technician for help.</p>

UV Process

The UV light has shorter wavelength (higher energy) than the visible light. It is called ultra-violet because it is just beyond violet light in the light spectrum. Technically, the ultra-violet light is defined to be any wavelength of light, which is shorter than 400 nanometer. UV rays, which penetrate into the micro-organisms, are absorbed by the DNA of the pathogen in the water. The DNA is altered in such a way that the pathogen cannot reproduce itself. Thus, it is essentially killed and cannot cause infection. This process of DNA modification is called inactivation.

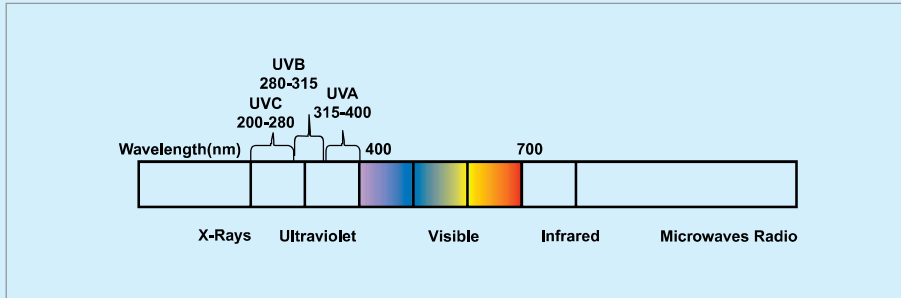

Automatic Operation

- The purifier automatically shuts off when the storage tank is full
- The purifier does not start when the inlet water supply pressure falls below 0.5 kg/cm²
- The purifier automatically restarts when water level drops below the maximum
- The purifier doesn't allow any water rejection in the absence of electricity or when the tank is full

UV Fail Alarm

KENT Sterling UV Purifier has an in built feature that produces an audible alarm if the UV lamp malfunctions. This feature is provided to ensure pure water.

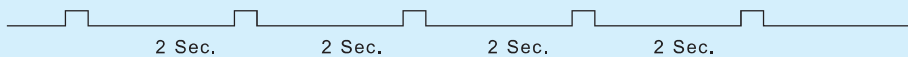

In case the alarm is audible, kindly switch off the purifier and call the service technician for help. The purifier will stop its purification process in such a circumstance.

Water Flow Diagram

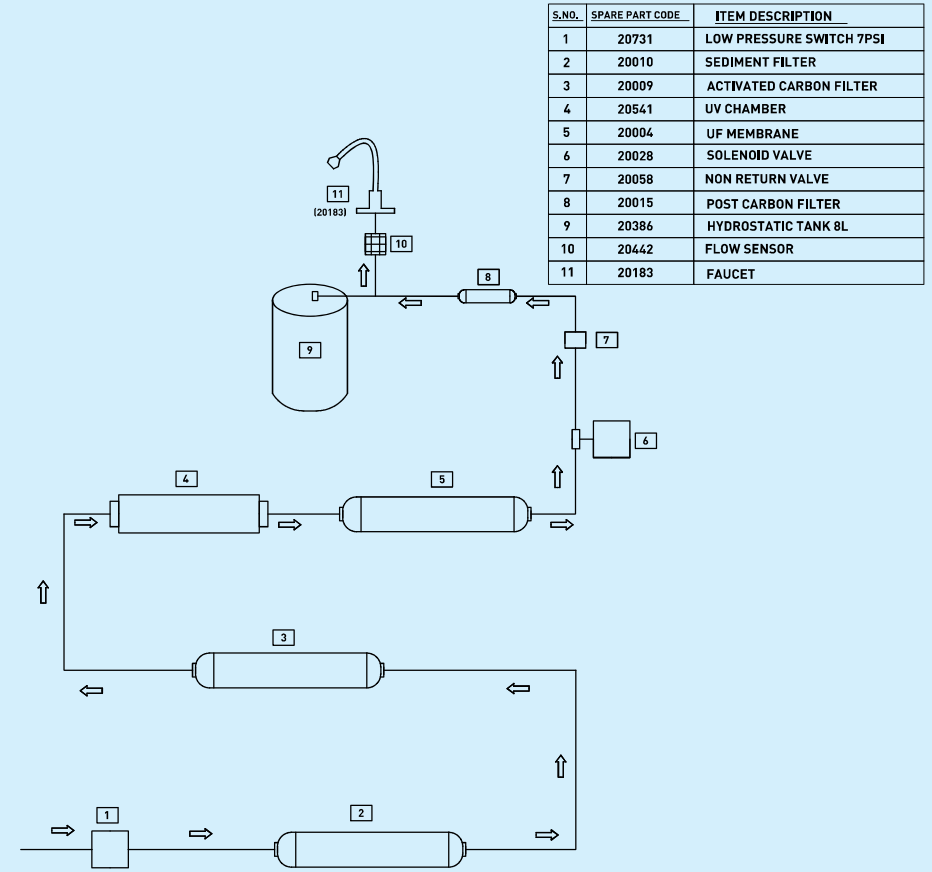

Electrical Circuit Diagram

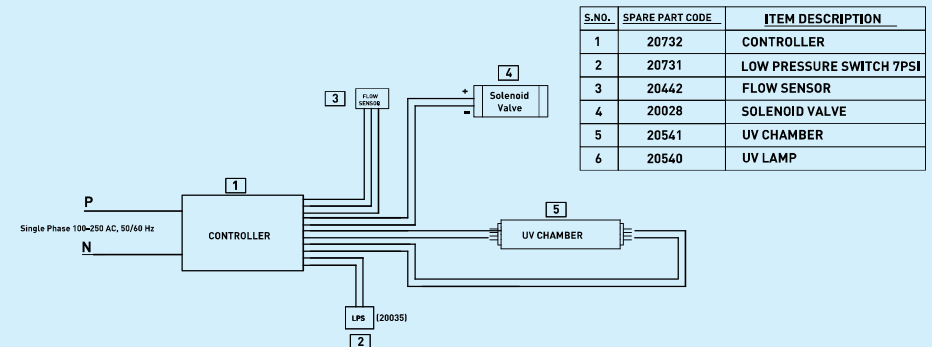

Installation Instructions

KENT Sterling UV Purifier is a convenient and user-friendly under-the-counter model.

Recommended Site Preparations

- Single Phase 100-250 V AC, 50-60 Hz. supply, not more than 3 m away from the point of installation
- Raw water supply with ½ inch nipple not more than 3 m away
- Installation space as per the dimensions of the purifier
- For optimum inlet pressure, source water tank should be at least 10 ft above the installed purifier
- Install the purifier near a sink for easy availability of inlet water lines
- The system and installation need to comply with state and local laws and regulations

Installation Procedure:

- Fix the SS ball valve to the ¼ inch port of the 3-way connector as shown in the figure
- Connect the 3-way connector to the raw water supply as shown in the figure. The threaded end of the 3-way connector is fit in-line with the raw water supply. The other end can be connected to a tap or plugged off, if not required
- Now connect one end of the white pipe 3/8" to the SS ball valve and other end to the lower pushfit elbow fitting on the back side of the purifier labeled as 'Water In'
- Install the faucet on the kitchen sink or the slab. Connect one end of the white pipe ¼" to the faucet and the other end to the fitting connector labeled as 'Faucet'
- Before connecting the power supply, it is important that you perform the following functions:
 - i. Open the SS ball valve (Handle parallel to the ball valve) to start the flow of water into the purifier
 - ii. Wait for 2-3 minutes to ensure that the filters are soaked in water

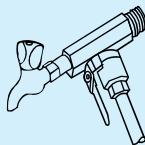
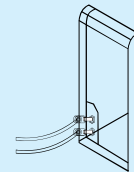
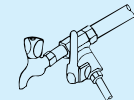
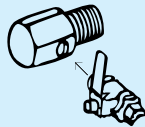

Starting-up the Purifier

- Switch on the power supply
- Wait approximately for 15 minutes so that the storage tank is full**
- Switch off the power supply
- Drain off the storage tank by opening the faucet to remove any dust particles from the pipe and storage tank
- Close the faucet & switch on the power supply
- The purifier is ready to use

****Tested & certified Flushing Time - 24 Hours.**

Maintenance

To ensure that the purifier operates at its best, a routine maintenance must be performed. The frequency of the maintenance will greatly depend upon the raw water quality and consumption of purified water.

- Storage tank must be drained once in a week
- Replace sediment filter and activated carbon filter once in 12 months or earlier if they get clogged.
- Replace UV lamp once a year
- In the event of not using the purifier for a long time (while going for a holiday, tour, etc.), ensure that you disconnect the power supply, turn off the raw water supply and drain out the storage tank

Replacement of spare parts are as under:

- 20010 SP Inline Sediment Filter 8"
- 20009 SP Inline Carbon Filter 8"
- 20015 SP Post Carbon Filter (Blue)
- 20004 SP UF Membrane 8"

Note: Replacement time of consumables such as filters and membrane is dependent on the quality of raw water and quantity of water consumed.

Important Safety Instructions

- If the supply cord is damaged, it must be replaced by the original part in order to avoid hazard
- Children should be supervised to ensure that they do not play with the appliance
- This appliance is not intended for use by persons (including children) with reduced physical, sensory or mental capabilities, or lack of experience and knowledge, unless they have been given supervision or instruction concerning use of the appliance by a person responsible for their safety

Warning

- Do not operate the UV-C emitter when it is removed from the appliance enclosure
- Read the maintenance instructions before opening the appliance
- The appliance must be disconnected from the supply before replacing the UV-C emitter

Technical Specifications

Product	KENT Sterling UV
Product Code	11077
Product Generic Name	Water Purifier
Product Colour	White
Applications	Suitable for Tap Water/Municipal Water Supply
Purification Production Rate	60L/hr. (Depending on Inlet Water Pressure)
Body Material	ABS Food Grade Plastic
Mounting	Under-the-counter
Dimensions (mm)	445 (L) x 245 (W) x 420 (H)
Inlet Water Pressure / Temp. (Min.)	0.5 kg/cm ² /10° C
Inlet Water Pressure / Temp. (Max.)	4 kg/cm ² /40° C
Filter Cartridge	Sediment, Activated Carbon, UF and Post Carbon
UV Lamp Wattage	11 W
Life of UV Lamp	5000 hrs. of operation
Maximum Duty Cycle	300 L/day
Net Weight	9.5 kg
Total Power Consumption	20 W
Input Power Supply	Single Phase 100-250 V AC, 50-60 Hz. 
IP Rating	IPX1

Testing Information

The System has been tested according to IS 10500:2012 (Standards for drinking water as per Bureau of Indian Standards) for reduction of the hazardous substances.