

# KENT Sterling+

Under-the-counter RO Water Purifier  
with a built-in hydrostatic tank

— Single Cabinet —

**KENT**

Mineral RO™

Water Purifiers

HOUSE of PURITY

## Instructions Handbook



### **Mineral RO™ TECHNOLOGY**

Removes Dissolved Impurities  
Retains Essential Minerals  
Multiple Purification

**RO + UV + UF + TDS Control**

*Kent Deta Hai*

**Sabse  
Shudh Paani**



Mineral RO™ © 2005 – 2019 Kent RO Systems Limited.

The process and the purifier is patented vide a Patent No. 199716



# Welcome to KENT

Dear Customer,

Welcome to the world of the KENT, leaders of water purification industry in India. With a KENT product, you have all the reasons to smile, because at KENT we take pride in the quality and laboratory-tested performance of our products.

We are confident that your decision to own **KENT Sterling+ Mineral RO™ Water Purifier** will go a long way in serving you with pure and mineral enriched drinking water, thus keeping you and your family in good health. We assure you that you will be satisfied with its trouble-free performance and quality which comes without any compromise.

This manual is an effort towards familiarising you with the operation and maintenance of **KENT Sterling+ Mineral RO™ Water Purifier**. Before operating the unit, please read it thoroughly and retain it for future reference. To ensure that the warranty of your water purifier is effective, fill up the enclosed warranty card and send the installation report within 15 days of purchase. Should you need further assistance, do not hesitate to contact your nearest KENT dealer or branch.

Best Wishes,

**KENT RO SYSTEMS LTD.**

## Table of Contents

1.	KENT TECHNOLOGY - A Breakthrough in Water Purification	1
2.	Salient Features	2
3.	Items in the Box	2
4.	Important Instructions	3
5.	Reverse Osmosis Process	4
6.	UV Process	4
7.	Water Flow Diagram	5
8.	Electrical Circuit Diagram	5
9.	UV Fail Alarm	6
10.	Automatic Operation	6
11.	Installation Instructions	6
12.	TDS Adjustment	7
13.	Starting-up the Purifier	7
14.	Recommended Usage of Rejected Water	8
15.	Maintenance	8
14.	Important Safety Instructions	9
15.	Warning	9
14.	Technical Specifications	10
15.	Testing Information	10



## KENT TECHNOLOGY - A Breakthrough in Water Purification\*

KENT proudly presents **KENT Sterling+ Mineral RO™ Water Purifier** - a new and advanced domestic water purifier which provides pure & healthy drinking water.

The futuristic **KENT Sterling+ Mineral RO™ Water Purifier**, developed at KENT Laboratory broadly comprises of state-of-the-art RO+UV+UF+TDS Control System. The initial purification by RO membrane having porosity as fine as 0.0001 microns reduces even the dissolved impurities (hard salts, heavy metals, etc.). Double purification by UV membrane gives additional protection from deadly harmful micro-organisms. Moreover, the patented TDS Control System intelligently retains essential natural minerals in purified water, thus taking total care of your health and wellbeing.

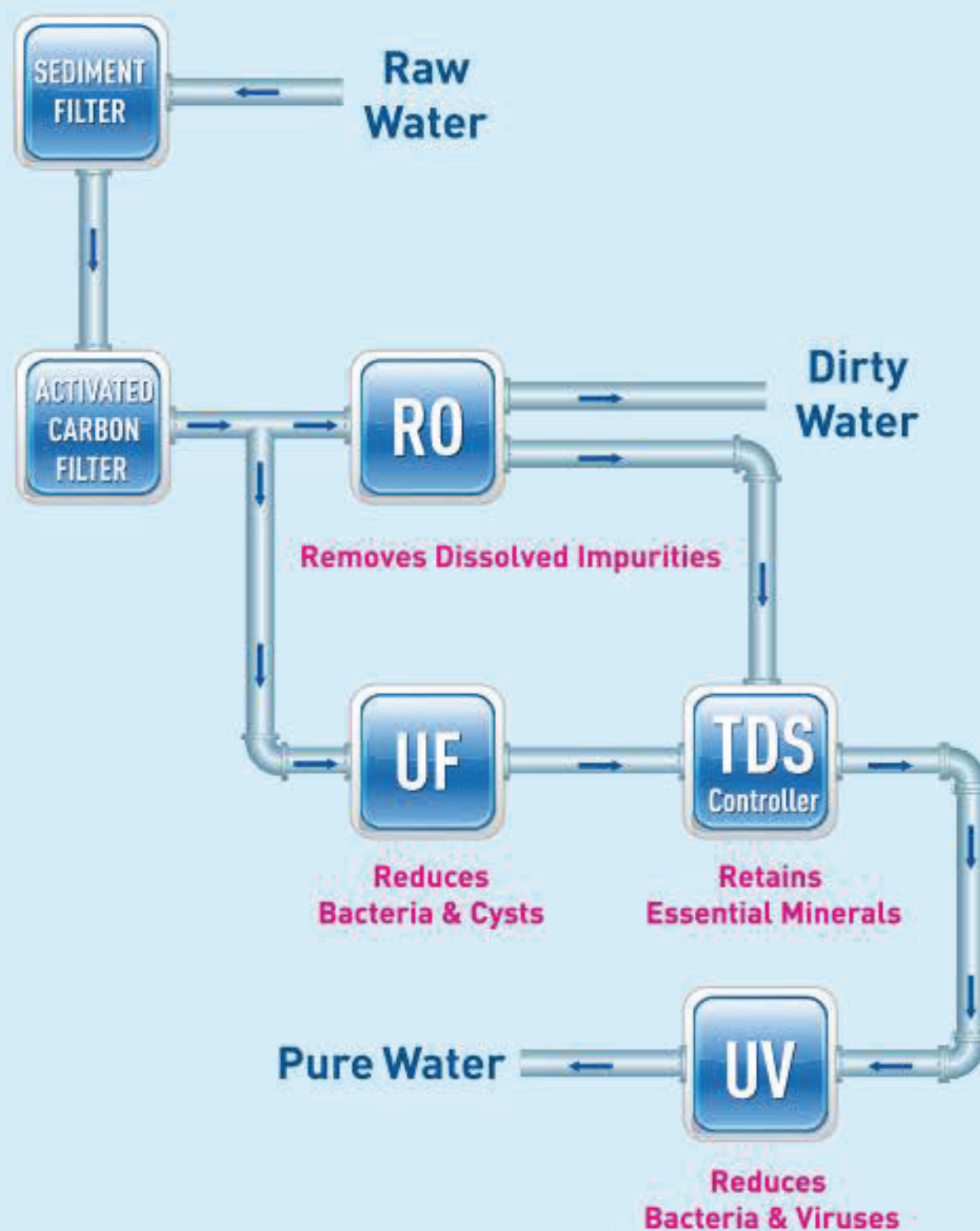

\* Tested & certified by TUV-SUD South Asia (P) Ltd.



## Salient Features of KENT Sterling+ Mineral RO™ Water Purifier

1. Compact single cabinet design for under-the-counter placement.
2. Double purification by RO + UV\* with TDS Control Valve.
3. Retains essential natural minerals in water with TDS Control Valve.
4. UV Fail Alarm\* to indicate failure in UV system.
5. 6 litres inbuilt hydrostatic storage tank makes purified water available on demand.
6. Fully automatic operation with auto-on/off.
7. Suitable for brackish / tap water/ municipal water supply.
8. Built-in SMPS to operate within 100–250V AC, voltage.
9. Tamper-proof RO Purifier.
10. Membrane fused inside membrane housing.
11. Ideal for under-the-counter as well as side-by-side placement adjacent to refrigerator.











### Items in the Box

1 KENT Sterling+ Mineral RO™ Water Purifier	: 01 No.
2 3-Way Connector	: 01 No.
3 S.S. Ball Valve	: 01 No.
4 Faucet	: 01 No.
5 Instruction Handbook	: 01 No.
6 Food Grade Pipe ¼" (Blue)	: 2.5 m
7 Food Grade Pipe ¼" (White)	: 2.5 m
8 Food Grade Pipe ¾" (white)	: 2.5 m

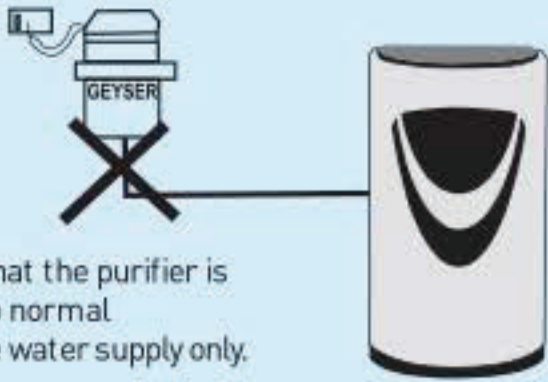
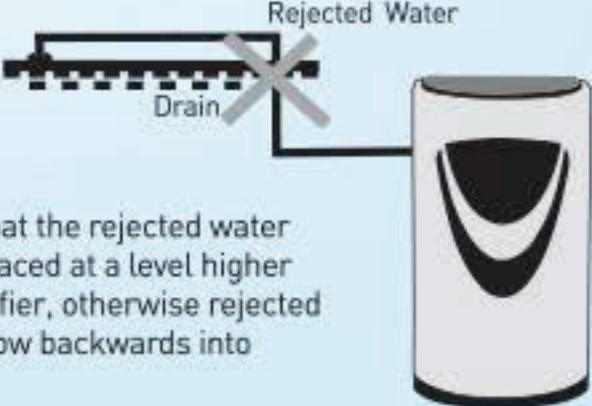
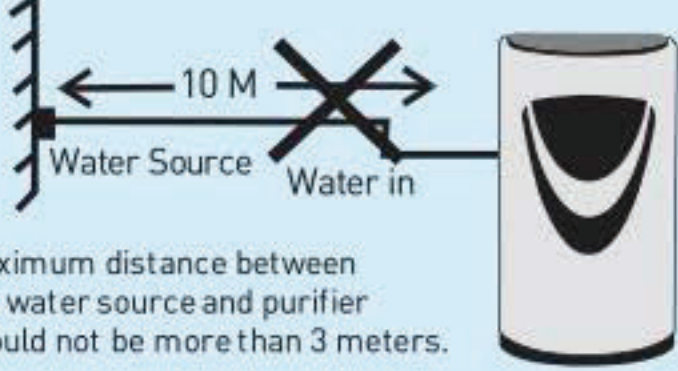
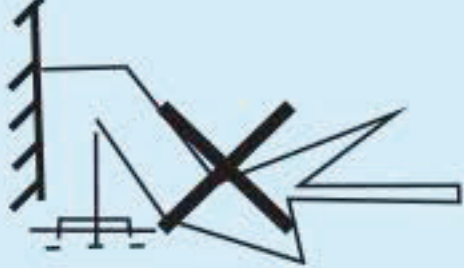
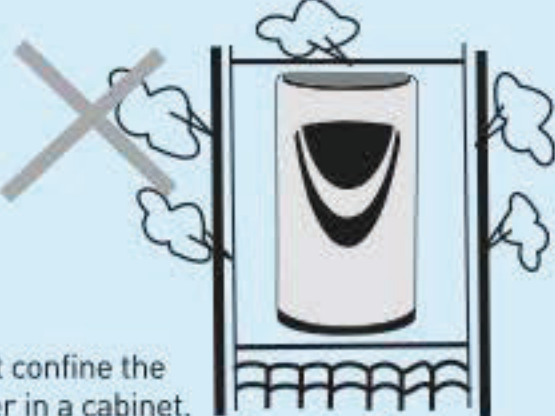
\*Tested & certified by TUV-SUD South Asia (P) Ltd.



## Important Instructions

  <p>Avoid exposure to direct sunlight and installation in damp areas.</p>	 <p>Make sure that the purifier is connected to normal temperature water supply only.</p>
 <p>Make sure that the rejected water pipe is not placed at a level higher than the purifier, otherwise rejected water may flow backwards into the purifier.</p>	 <p>Maximum distance between the water source and purifier should not be more than 3 meters.</p>
 <p>Avoid sharp bends in pipes.</p>	 <p>Do not confine the purifier in a cabinet.</p>
  <p>In case of not using the purifier for more than two days, kindly switch off the power supply and drain out the storage tank.</p>	 <p>To keep the storage tank clean, it should be drained once in 15 days.</p>
<p style="text-align: center;"><b>KENT</b></p>  <p style="text-align: center;">Use Genuine KENT spares for optimum performance.</p>	  <p>Do not try to service the purifier on your own. Instead, call service technician for help.</p>



## Reverse Osmosis Process

Reverse Osmosis process, also known as hyper filtration, is the finest filtration process known till date. It ensures reduction of particles as small as ions from a solution. Reverse Osmosis process uses a semi-permeable membrane to reduce salts from potable/brackish water. In Reverse Osmosis, water pressure is applied to the inlet impure water resulting in squeezing of pure water from the concentrated end of membrane towards the diluted end. Dissolved salts present in water as charged ions, get repelled by the RO membrane and are not allowed to pass through. Similarly, bacteria and germs are also blocked by the ultra fine pores of the RO membrane. These rejected impurities suspended on the concentrated end of the membrane are washed away in a stream of waste water, preventing the membrane from clogging.

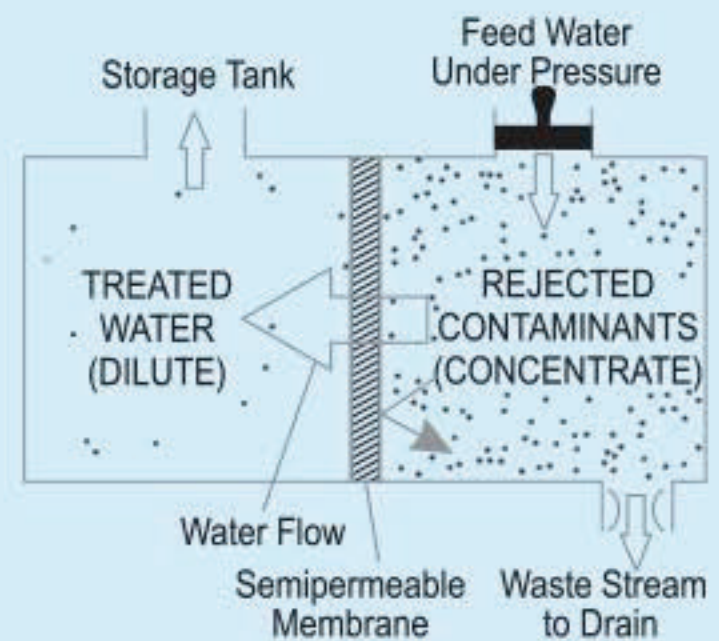

## UV Process

The UV light has shorter wavelength (higher energy) than the visible light. It is called ultra-violet because it is just beyond violet light in the light spectrum. Technically, the ultra-violet light is defined to be any wavelength of light, which is shorter than 400 nanometer. UV rays, which penetrate into the micro-organisms, are absorbed by the DNA of the pathogen in the water. The DNA is altered in such a way that the pathogen cannot reproduce itself. Thus, it is essentially killed and cannot cause infection. This process of DNA modification is called inactivation.

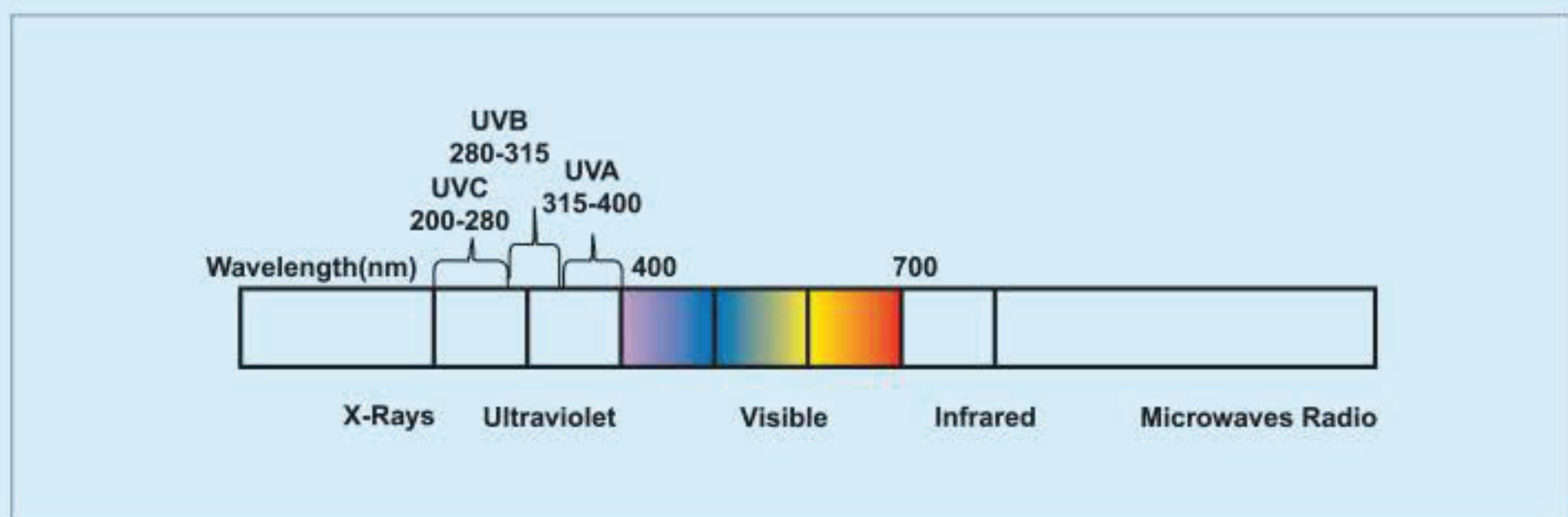



## Water Flow Diagram

S.NO.	SP - CO.	ITEM DESCRIPTION
1	20035	LOW PRESSURE SWITCH
2	20010	SEDIMENT FILTER
3	20028	SOLENOID VALVE
4	20005	BOOSTER PUMP
5	20009	ACTIVATED CARBON FILTER
6	20003	UF FILTER
7	20529	RO MEMBRANE
8	20034	TDS CONTROL VALVE
9	20020	FLOW RESTRICTOR TUBE
10	20541	UV CHAMBER
11	20015	POST CARBON FILTER
12	20058	NON RETURN VALVE
13	20036	HIGH PRESSURE SWITCH
14	20386	HYDROSTATIC STORAGE TANK
15	20183	FAUCET

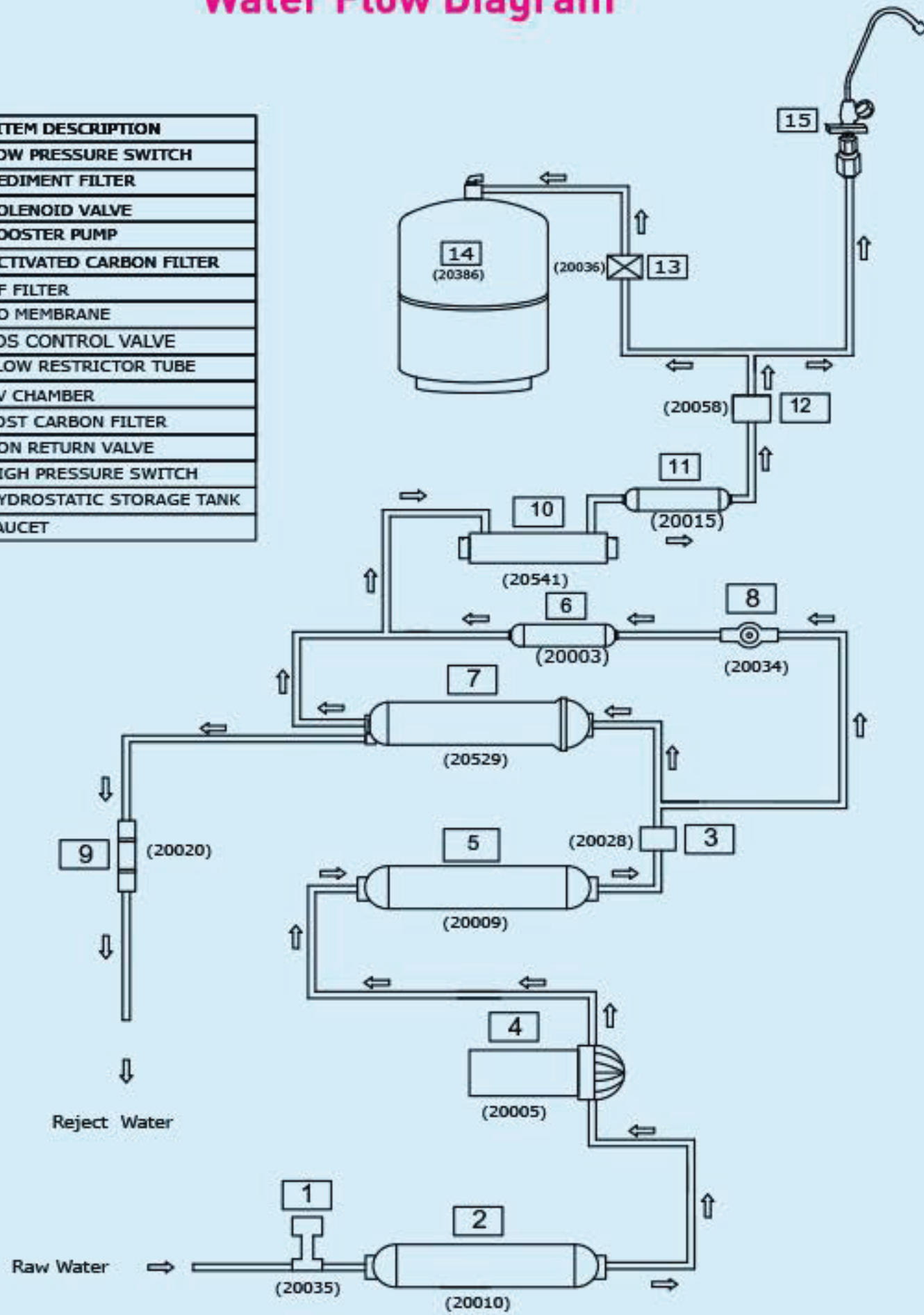

## Electrical Circuit Diagram

S.NO.	SPARE PART CODE	ITEM DESCRIPTION
1	20016	SMPS
2	20035	LOW PRESSURE SWITCH
3	20036	HIGH PRESSURE SWITCH
4	20028	SOLENOID VALVE
5	20005	BOOSTER PUMP
6	20059	PUMP HEAD
7	20022	BALLAST
8	20541	UV CHAMBER
9	20540	UV LAMP

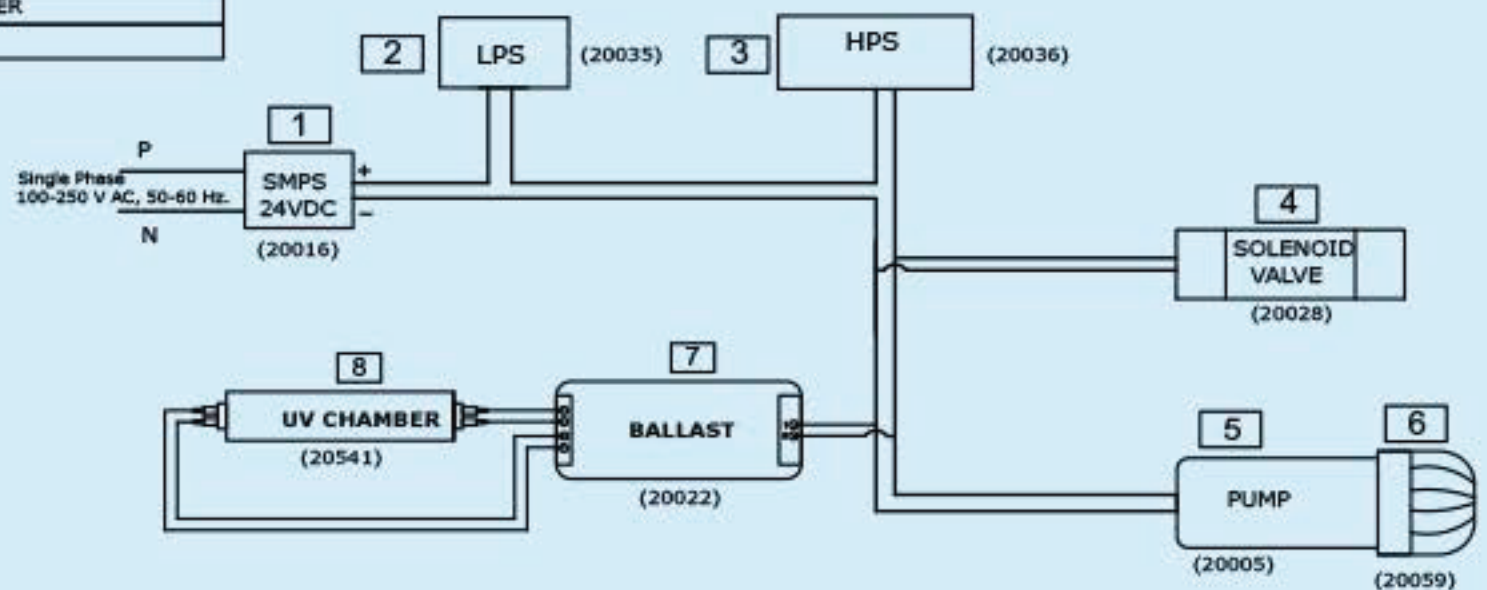



## UV Fail Alarm\*

**KENT Sterling+ Mineral RO™ Water Purifier** has an in built feature that produces an audible alarm if the UV lamp malfunctions. This feature is provided to ensure pure water.

In case the alarm is audible, kindly switch off the purifier and call the service technician for help. The purifier will stop its purification process in such a circumstance.

## Automatic Operation

- The purifier automatically shuts off when the storage tank is full
- The purifier does not start when inlet water supply pressure falls below 0.3 kg/cm<sup>2</sup>
- The purifier automatically restarts when water level drops below the maximum
- The purifier doesn't allow any water rejection in absence of electricity or when the tank is full

## Installation Instructions

**KENT Sterling+ Mineral RO™ Water Purifier** is a convenient and user-friendly under-the-counter model.

### Recommended Site Preparations:

- Single Phase 100-250 V AC, 50-60 Hz. supply, not more than 3 m away from the point of installation
- Raw water supply with ½ inch nipple not more than 3 m away
- Drain for reject water not more than 3 m away
- Installation space as per the dimensions of the purifier
- For optimum inlet pressure, source water tank should be at least 10 ft above the installed purifier
- Install the purifier near a sink for easy availability of inlet and reject water lines
- The system and installation need to comply with state and local laws and regulations

### Installation Procedure:

- Fix the SS ball valve to the ¼ inch port of the 3-way connector as shown in the figure
- Connect the 3-way connector to the raw water supply as shown in the figure. The threaded end of the 3-way connector is fit in-line with the raw water supply. The other end can be connected to a tap or plugged off, if not required





- Now connect one end of the white pipe  $\frac{3}{8}$ " to the SS ball valve and other end to the lower pushfit elbow fitting on the back side of the purifier labeled as 'Water In'
- Similarly, connect one end of the blue pipe to the fitting connector labeled as 'Reject Water' and leave the other end in the drain

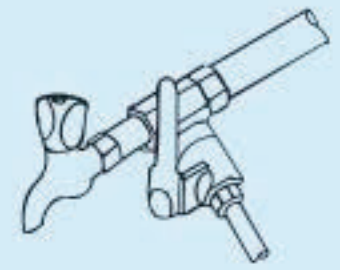

 Use blue pipe for reject water.

- Install the faucet on the kitchen sink or the slab. Connect one end of the white pipe  $\frac{1}{4}$ " to the faucet and the other end to the fitting connector labeled as 'Faucet'
- Before connecting the power supply, it is important that you perform the following functions:
  - i Open the SS ball valve (Handle parallel to the ball valve) to start the flow of water into the purifier
  - ii Wait for 2-3 minutes to ensure that the filters are soaked in water

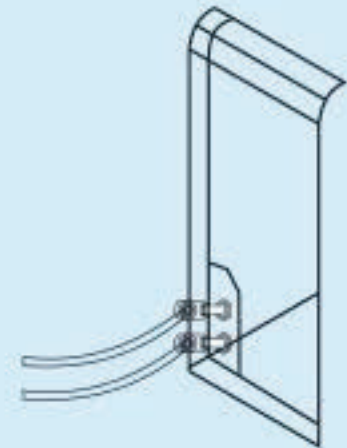

### TDS Adjustment\*

The unique TDS Controller enables customers to retain the contents of natural minerals in purified water, as per their requirement.

- |   |   |
|---|---|
| <ul style="list-style-type: none"> <li>• Turning the screw of the valve anticlockwise, results in an increased mineral content</li> </ul> | <ul style="list-style-type: none"> <li>• Turning the screw of the valve clockwise results in a decreased mineral content</li> </ul> |
|---|---|

 We recommend keeping the TDS at the lowest possible level but not below 50mg/l.

### Starting-up the Purifier

- |  |   |
|--|---|
| <ul style="list-style-type: none"> <li>• Switch on the power supply</li> <li>• Wait approximately for half an hour so that the storage tank is full**</li> <li>• Switch off the power supply</li> <li>• Drain off the storage tank by</li> </ul> | <ul style="list-style-type: none"> <li>• opening the faucet to remove any dust particles from the pipe and storage tank</li> <li>• Close the faucet &amp; switch on the power supply</li> <li>• The purifier is ready to use</li> </ul> |
|--|---|

\* Tested & certified by TUV-SUD South Asia (P) Ltd.

\*\*Tested & certified Flushing Time - 24 Hours.



## Recommended Usage of Rejected Water

Although the rejected water has high concentration of salts, it is absolutely clean and free from impurities like chlorine, dirt, sand, etc. This rejected water usually goes down the drain, but it can be used for gardening purposes. The high concentration of salts and minerals accelerate plant growth. Rejected water can also be used for cleaning utensils, mopping, etc.

## Maintenance

To ensure that the purifier operates at its best, a routine maintenance must be performed. The frequency of the maintenance will greatly depend upon the raw water quality and consumption of purified water.

- Storage tank must be drained once in a week
- Replace sediment filter and activated carbon filter once in 12 months or earlier if they get clogged. It is recommended to change the FRT along with the filters
- Replace RO membrane once in a year or earlier if it gets clogged
- Replace UV lamp once a year
- In the event of not using the purifier for a long time (while going for a holiday, tour, etc.), ensure that you disconnect the power supply, turn off the raw water supply and drain out the storage tank

### Replacement of spare parts are as under:

-20010	SP Inline Sediment Filter 8"
-20009	SP Inline Carbon Filter 8"
-20529	SP RO Membrane
-20015	SP Post Carbon Filter (Blue)
-20003	SP Hollow Fibre Membrane (RO)
-20020	SP FRT 300/450

**Note:** Filters and membranes are consumables. Their replacement time is dependent on the quality of raw water and water consumption. They are not covered under the warranty. However, if a filter chokes within six months and a membrane within a year, it will be cleaned/repared/replaced free of cost. Changing the filters and system inspection is available on call. The treatment capacity of RO membrane will reduce with time due to clogging of pores of membranes.

This reverse osmosis system contains a replaceable component critical to the efficiency of the system. Replacement of the reverse osmosis component should be with one of identical specifications as defined by the manufacturer, to ensure the same efficiency and contaminant reduction performance.



## **Important Safety Instructions**

- If the supply cord is damaged, it must be replaced by the original part in order to avoid hazard
- Children should be supervised to ensure that they do not play with the appliance
- This appliance is not intended for use by persons (including children) with reduced physical, sensory or mental capabilities, or lack of experience and knowledge, unless they have been given supervision or instruction concerning use of the appliance by a person responsible for their safety

## **Warning**

- Do not operate the UV-C emitter when it is removed from the appliance enclosure
- Read the maintenance instructions before opening the appliance
- The appliance must be disconnected from the supply before replacing the UV-C emitter



## Technical Specifications

Product	KENT STERLING <sup>+</sup>
Product Code	111053
Product Generic Name	Water Purifier
Product Colour	White
Applications	Suitable for Brackish/Tap Water/Municipal Water Supply
Purification Production Rate	Upto 20 L/hr.*
Body Material	ABS Food Grade Plastic
Mounting	Under-the-counter
Dimensions (mm)	445 (L) x 245 (W) x 420 (H)
Inlet Water Pressure / Temp. (Min.)	0.3 kg/cm <sup>2</sup> /10° C
Inlet Water Pressure / Temp. (Max.)	4.0 kg/cm <sup>2</sup> /40° C
Min./Max. Operating pH	6.5-8.0
Filter Cartridge	Sediment, Activated Carbon, UF and Post Carbon
UV Lamp Wattage	11 W
Life of UV Lamp	5000 hrs. of operation
UF Membrane	0.01-0.1 microns
RO Membrane	Thin Film Composite RO
Storage Capacity	6 Litres
Maximum Duty Cycle	100 L/day
Net Weight	11.90 kg
Booster Pump Voltage	24V DC
Total Power Consumption	60 W
Input Power Supply	Single Phase 100-250 V AC, 50 -60Hz. 
IP Number	IPX1

\* Purification capacity tested for raw water having TDS level of 750 ppm at room temperature.

## Testing Information

The System has been tested according to IS 10500:2012 (Standards for drinking water as per Bureau of Indian Standards) for reduction of the hazardous substances.



**KENT**  
*Mineral RO™*  
**Water Purifiers**  
**HOUSE of PURITY**



**SERVICE**

\*To request for service 24x7, download KENT Service App by scanning the QR code or by giving a missed call: 9212252852



To speak to customer care executive call: 92-789-12345



Innovations for Better Living

Marketed by:  
**KENT RO SYSTEMS LTD.**  
E-6, 7 & 8, Sector-59, Noida, U.P.-201 309, India.  
E-mail: [sales@kent.co.in](mailto:sales@kent.co.in) | Website: [www.kent.co.in](http://www.kent.co.in)

Manufactured by:  
**KENT RO SYSTEMS LTD.**  
1. Khasra No. 93, Village-Bantakhedi, Tehsil-Roorkee, District-Haridwar, Uttarakhand-247 668, India.

2. A-6, Sector-87, Noida-201305, U.P., India.

**For customer complaints, contact our Customer Care Officer at:**  
E-6, 7 & 8, Sector-59, Noida, U.P.-201 309, India. Call: 92-789-12345  
E-mail: [service@kent.co.in](mailto:service@kent.co.in) or visit us at [www.kent.co.in](http://www.kent.co.in)