

# KENT Supreme

MULTIPLE PURIFICATION BY RO + UF + TDS CONTROL

**KENT**

Mineral RO™

Water Purifiers

HOUSE of PURITY

## Instructions Handbook

Meets  
IS 16240:  
2023

**KENT**  
Mineral RO™  
Water Purifiers

HOUSE of PURITY



**KENT® TECHNOLOGY**  
Removes Dissolved Impurities  
Retains Essential Minerals  
Multiple Purification with Purity in Every Drop  
RO + UF + TDS Control + UV in Tank

Kent Deta Hai  
**Sabse  
Shudh Paani**

Marketed by:  
**KENT RO SYSTEMS LTD.**  
E-6, Sector-59, Noida, U.P.-201 309, India.  
E-mail: sales@kent.co.in | Website: www.kent.co.in

For customer complaints, contact our Customer Care Officer at:  
E-6, Sector-59, Noida, U.P.-201 309, India. Call: 92-789-12345  
E-mail: service@kent.co.in or visit us at www.kent.co.in

Made in India

Mineral RO © 2005 KENT RO SYSTEMS LTD. The process & purifier is patented vide patent no. 199716.  
KENT Supreme design is registered vide registration no. 250332

# Welcome to KENT

Dear Customer,

At the outset, allow us to thank you for your trust in KENT water purifier. We take pride in our reputation for product quality and industry proven performance. We are certain that your decision to own **KENT Supreme Mineral RO™** water purifier will go a long way towards keeping you and your family in good health. We are confident that you will be satisfied with its performance and that it will serve your need for safer and cleaner drinking water without any compromise.

This guide will help you in getting the best out of your water purifier. Please go through this booklet to familiarize yourself with its operation and maintenance.

Best Wishes,

KENT RO SYSTEMS LTD.

## Table of Contents

1. KENT Technology - A Breakthrough in Water Purification	1
2. Salient Features of KENT Supreme	1
3. Items in the Box	1
4. Important Instructions	2
5. Reverse Osmosis Process	3
6. Auto-Flushing System	3
7. Filter Change Alarm	3
8. Water Flow Diagram	4
9. Electrical Circuit Diagram	4
10. Automatic Operation	5
11. Installation Instructions	5
12. TDS Adjustment	6
13. Starting-up the Purifier	7
14. Maintenance	7
16. Important Safety Instructions	8
17. Warning	8
17. Technical Specifications	9
18. Testing Information	9
19. Performance Data Sheet	10

# KENT TECHNOLOGY - A Breakthrough in Water Purification

Presenting the **KENT Supreme Mineral RO™** Water Purifier; it uses futuristic and state-of-the-art technology to provide pure & healthier drinking water.

The heart of **KENT Supreme Mineral RO™** Water Purifier is a Reverse Osmosis membrane having capillaries as small as 0.0001 microns that reduces even dissolved impurities (salts and heavy metals) and even converts hard water to sweet and purer drinking water. **KENT Supreme Mineral RO™** Water Purifier also allows the user to control the Total Dissolved Solids (TDS) level of purified water.

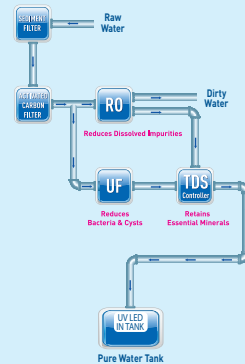







## Salient Features

- Water purifier with UV Disinfection in tank to keep purified water pure
- High water recovery
- Wall-mountable KENT Technology water purifier
- Purification by RO + UF + TDS Control + UV in tank makes water pure
- Inbuilt TDS Controller that allows adjustment of TDS level of purified water
- Suitable for Purification of Brackish / Tap Water/ Municipal Water Supply
- 8 L storage tank with water level indicator
- Fully automatic operation, with auto-on and auto-off function
- RO Membrane fused inside membrane housing to prevent tampering
- Vertically mounted SMPS for protection from water
- Use of push-fit fittings for leakage and maintenance free performance
- Compact design, takes less space for installation
- ABS construction for corrosion free use
- We are not using any preservative in RO Membrane.

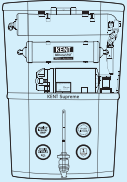
## Items in the Box

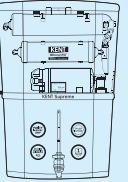
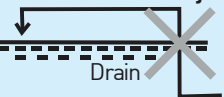
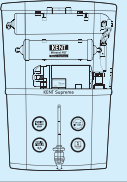
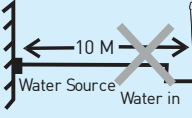
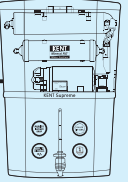
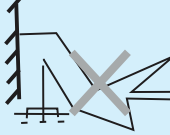
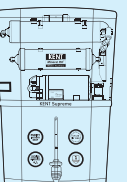
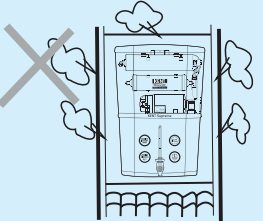
- |  |   |          |
|--|---|----------|
| 1. KENT Supreme Mineral RO™ Water Purifier | : | 1 N      |
| 2. 3-Way Connector                         | : | 1 N      |
| 3. S.S. Ball Valve                         | : | 1 N      |
| 4. Food Grade Pipe - 1/4 inch (White)      | : | 2.5 m    |
| 5. Food Grade Pipe - 3/8 inch (White)      | : | 2.5 m    |
| 6. Screws & Plastic Inserts                | : | 2 N each |
| 7. Sticker Center Drill                    | : | 1 N      |
| 8. TDS Meter                               | : | 1 N      |

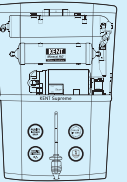
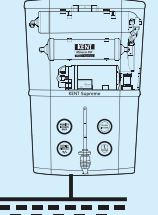
## Important Instructions

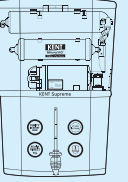
 <p>Avoid exposure to direct sunlight and installation in damp areas.</p> 	 <p>Make sure that the temperature of the water entering the purifier is within 10°C - 40°C.</p> 
<p><b>Reject Water</b></p>  <p>Make sure that the reject water pipe is not placed at a level higher than the system, otherwise the rejected water may flow backwards into the purifier.</p> 	 <p>Maximum distance between the water Source and the purifier should not be More than 3 meters.</p> 
 <p>Avoid Sharp bends in the pipe Fittings. Do not bend or block the reject water pipe.</p> 	 <p>Do not confine the Purifier in a cabinet.</p>
 <p>In case of not using the purifier for More than two days, kindly switch off the power supply and drain the Storage tank.</p> 	 <p>To keep the storage tank Clean, it should be drained once in 15 days.</p>
<p><b>KENT</b></p> <p><b>GENUINE</b></p> <p><b>SPARE PARTS</b></p> <p>Use Genuine KENT Spares for optimum performance.</p>	 <p>Do not try to service the purifier on your own. Instead, call a technician for help.</p> 

## Reverse Osmosis Process

The Reverse Osmosis process, also known as hyper filtration, is the finest filtration process known till date. The process ensures reduction of particles as small as ions from a solution. Reverse Osmosis uses a semi-permeable membrane to reduce salts from potable / brackish water. In Reverse Osmosis, water pressure applied to the concentrated side forces the process of osmosis into reverse. Under enough pressure, treated water is "squeezed" through the membrane from the concentrated side to the diluted side. Salts dissolved in water as charged ions are repelled by the RO membrane. The rejected impurities on the concentrated side of the membrane are washed away in a stream of waste water and thus do not get accumulated as in a traditional filter.

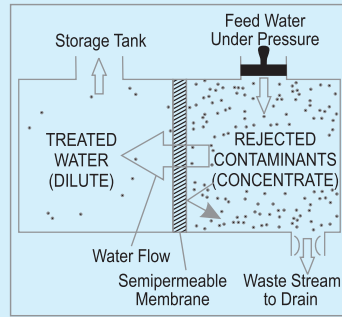

## Auto-Flushing System

The purpose of the Auto-flushing system is to help prevent scaling or fouling of the RO membrane by providing a rapid rinse which washes away impurities from the membrane's surface and keeps the membrane clean. It offers the following benefits:

- Lowers rejected water outflow
- Improves "TDS" rejection rate i.e increases the RO membrane's efficiency
- Extends the life of the RO membrane

## Filter Change Alarm\*

KENT Supreme Mineral ROT™ Water Purifier has an in-built feature that sounds an audible alarm to indicate replacement time for filters. This alarm will be audible after 700 hrs of use since the last filter change (or since the time of installation). The Filter Change Alarm will sound as follows:

4 short beeps after every two seconds; for 30 seconds. The alarm will repeat after every 2 hours of use.

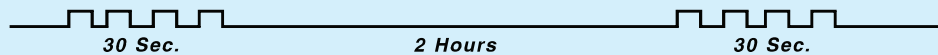

In case such an alarm is audible, please call the service technician and request him to change the filters of the purifier. However, if the filters are not changed within the next 60 hours of operation, the purifier will stop functioning to ensure purity and hygiene. The following alarm will be audible after 60 Hrs. A continuous beep for an infinite time.

In case, such an alarm is audible, kindly switch off the purifier and call the service technician to replace the filters. In such a circumstance, the purifier will not function unless the filters are changed.

## Computer Controlled Operation\*

To ensure delivery of purer and healthier water, a micro-processor is installed in the purifier that performs the following functions:

**UV Stabilization Delay:** To ensure that the UV lamp is pre-heated and is working at its optimum level before it starts disinfecting water, the controller provides a two seconds delay to UV lamp when the purifier is switched on. During this period, only the UV lamp is switched on and other electrical devices of the purifier are switched off.

**Purification Delay:** To ensure that the idle water lying in the internal pipes and in the UV chamber is disinfected before being passed into the storage tank, the system provides 5 second delay when the purifier is switched on. During this time, the UV lamp kills all micro-organisms that may be in the water inside UV chamber. After this delay, all other electrical devices such as booster pump and solenoid valve are switched on to start normal purification process.

**Audible Alarm:** The controller also controls the timing of UV Fail Alarm and the Filter Change Alarm.

## Water Flow Diagram

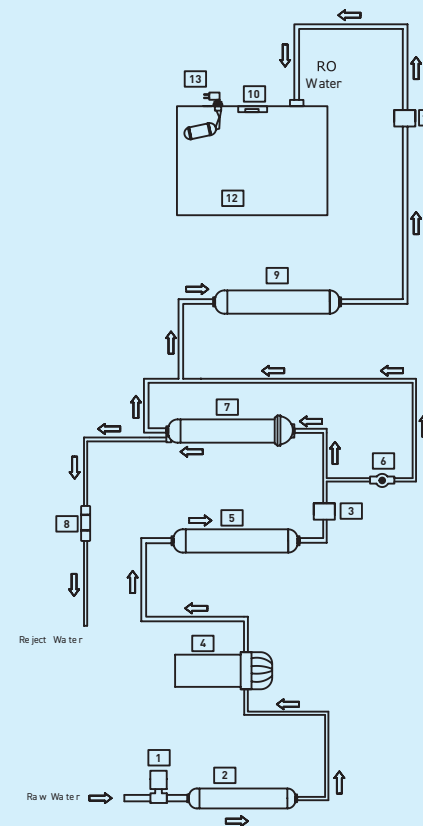

S.NO	SPARE PART CODE	ITEM DESCRIPTION
1	200035	LOW PRESSURE SWITCH
2	200010	SEDIMENT FILTER
3	200028	SOLENOID VALVE
4	200005	BOOSTER PUMP
5	200009	ACTIVATED CARBON FILTER
6	200034	TDS CONTROL VALVE
7	200529	RO MEMBRANE
8	202202	FLOW RESTRICTOR TUBE
9	200004	UF MEMBRANE
10	200621	UV LED
11	200058	NON RETURN VALVE
12	200148	WATER STORAGE TANK
13	200029	FLOAT MICRO SWITCH

## Electrical Circuit Diagram

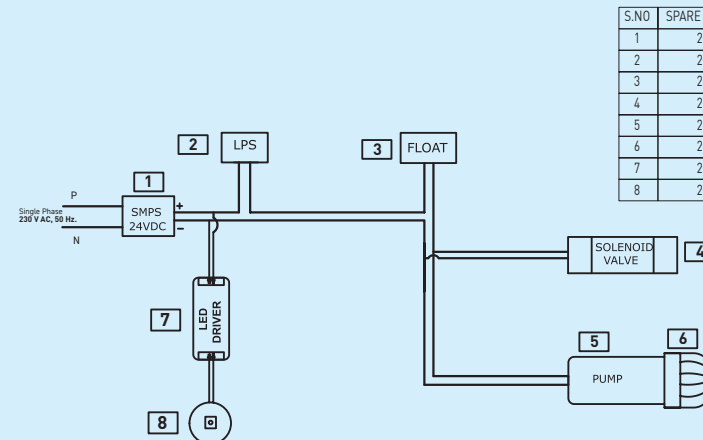

S.NO	SPARE PART CODE	ITEM DESCRIPTION
1	200016	SMPS
2	200035	LOW PRESSURE SWITCH
3	200029	FLOAT MICRO SWITCH
4	200028	SOLENOID VALVE
5	200005	BOOSTER PUMP
6	200059	PUMP HEAD
7	200620	UV LED DRIVER
8	200621	UV LED



[NOTE: The above specifications are subject to modifications for improvement without notice].

## Automatic Operation

- The purifier automatically shuts off when the storage tank is full
- The purifier does not allow any water rejection in absence of electricity / when tank is full
- The purifier automatically restarts when water level drops below the maximum
- The purifier does not start when inlet water supply pressure falls below 0.0344 Mpa - 0.3792 Mpa

## Installation Instructions

The **KENT Supreme Mineral RO™** Water Purifier is a product of advanced technology, which ensures safe and clean drinking water. The purifier is easy and convenient to install.

### Recommended Site Preparations:

- Single Phase 230 V AC, 50 Hz. Connection not more than 3m away from the point of installation of purifier
- Raw water supply with 1/2 inch nipple not more than 3m away
- Drain for rejected water not more than 3m away
- Space as per dimensions of the purifier
- Wall/plane surface for mounting two screws and holding the machine
- The system and installation must comply with state and local laws and regulations

### Specific Instructions:

- KENT Supreme Mineral RO™ Water Purifier is a wall-mounted purifier. Make sure that it is only mounted on a wall. Avoid installation on wooden and metallic stands
- For optimum performance and minimum inlet pressure required, ensure that the raw water supply tank is at least 10 ft above the level at which the purifier is installed
- It is preferable to install the purifier near a sink so that inlet and reject water lines are easily available

### Installation Procedure:

#### Step-1

#### Wall Hanging Diagram

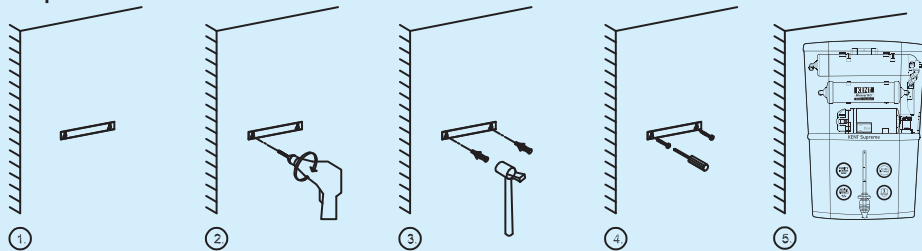

1. Paste the central drill sticker on wall at {3.6 feet to 4.0 Feet from the ground} as per your convenience.
2. Ensure that the sticker is pasted straight on the wall, then drill holes as per the space provided on sticker.
3. Now, insert the puff up with the help of a hammer.
4. Screw in two 10X50 self-taping screws, 5.4 inches (138 mm) apart horizontally.
5. Carefully hang the purifier on the wall with the help of wall-mounting slot holes provided on the back side of the purifier.

#### Note:

1. If the wall is not straight or the screws are not properly drilled in an even position, it will damage your purifier.
2. Keep the device away from heat or direct sunlight.

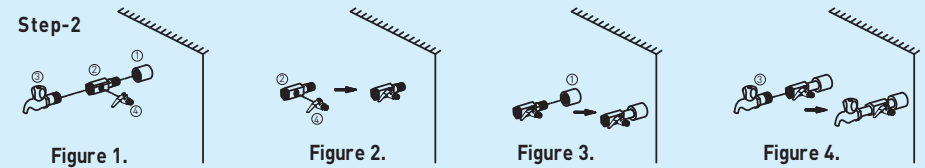

1. First fix the SS ball valve (marked as no. 4) to the 1/4 inch port of the 3-way connector (marked as no. 2) as shown in figure 2.
2. Connect the 3-way connector to the raw water supply (marked as no. 1) as shown in the figure 3. The 3-way connector is fit in line with the raw water supply.
3. The other end of the 3-way connector can be connected to a tap (marked as no.3) as shown in figure or can be plugged off if not required.

#### Step-3

1. Now connect one end of the white pipe to SS ball valve and another end to the upper push-fit elbow fitting to the left hand side of the purifier labeled as WATER IN, as shown in fig 1.
2. Similarly, connect one end of the white pipe to the lower elbow fitting connector in tank labeled as REJECT WATER and leave the other end in the drain, as shown in fig 2.

#### Step-4

Before connecting the power supply, it is important that you perform the following functions:

1. Open the SS ball valve (Handle parallel to the ball valve) to start the flow of water into the purifier, as shown in the figure.
2. Wait for 2-3 minutes to ensure that the filters are soaked in water.

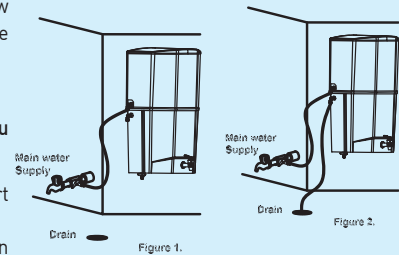

#### Step-5

1. Connect the power supply.
2. Installation is complete.

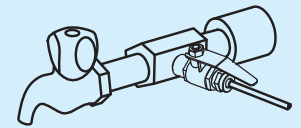

## TDS Adjustment

The unique TDS Controller enables customers to retain the contents of natural minerals in purified water, as per their requirement.

- Turning the screw of the valve anti-clockwise, results in an increased mineral content
- Turning the screw of the valve clockwise, results in a decreased mineral content
- TDS Meter Calibration certificate frequency is yearly.

1. Firstly, remove the protective cap from the TDS
2. Clean the cap and fill it the water. Turn on the TDS meter and dip the head of the TDS meter to test TDS level of water. Alternatively, you can also do the same procedure in the clean container to test the TDS of the water

3. Carefully immerse the meter into the water or solution up to the maximum immersion level, which is 2 inches. Allow the display to stabilize; this takes 10 to 30 seconds. The TDS meter will automatically compensate for any temperature variations once the reading has stabilized. Now, press the hold button to save the stabilized reading.
4. After using the meter, ensure to shake off any meter. Excess water or gently wipe it with a tissue to keep it clean and dry.

## Starting up the Purifier

- Switch on the power supply
- Allow the storage tank to fill to the maximum
- Switch off the power supply
- Open the upper cover. Lift and drain the Storage tank so as to remove residual dust Particles present in the pipes and storage
- Place back the storage tank and close the Upper cover
- Switch on the power supply
- Purifier is ready to use

## Maintenance

To ensure that the purifier operates at its optimum level, a routine maintenance must be performed. The frequency of the maintenance will greatly depend upon the raw water quality and consumption of treated water.

- Storage tank must be cleaned once in 2 weeks.
- Replace the sediment filter, activated carbon filter & post carbon filter once in 12 months or whenever the filter change alarm activates. it is recommended to change FRT along with the filters
- Replace the RO membrane once in a year
- Replace the UV Lamp once in a year
- In the event of not using purifier for a long time (while going for a holiday, tour etc.), make sure that you disconnect the power supply, turn off the raw water supply and drain the storage tank
- Cleaning and disinfection of the storage tank by halogenated solution (usually Chlorine) or any other equivalent disinfecting method in every three months.

The reverse osmosis system contains a replaceable treatment component critical for the effective reduction of total dissolved solids and that product water shall be tested periodically to verify that the system is performing properly.

### Replacement of space parts are as under:

-200010	SP	Inline Sediment Filter 8"
-200009	SP	Inline Carbon Filter 8"
-200529	SP	RO Membrane
-200015	SP	Post Carbon Filter (Blue)
-200003	SP	Hollow Fibre Membrane (RO)
-202202	SP	FRT 350

Note: Filters and membranes are consumables. Their replacement time depends upon the quality of raw water and water consumption. They are not covered under the warranty. However, if a filter chokes within six months and a membrane within a year, it will be cleaned/repared/replaced free of cost. Changing the filters and system inspection membranes is available on call. The treatment capacity of RO membrane will reduce with time due to clogging of pores of membranes.

"This reverse osmosis system contains a replaceable component critical to the efficiency of the system. Replacement of the reverse osmosis component should be with one of identical specifications as defined by the manufacturer, to ensure the same efficiency and contaminant reduction performance."

## Important Safety Instructions

- If the supply cord is damaged, it must be replaced by the original part in order to avoid hazard.
- Children should be supervised to ensure that they do not play with the appliance
- This appliance is not intended for use by persons (including children) with reduced physical or mental capabilities, or lack of experience and knowledge, unless they have been given supervision or instruction concerning use of the appliance by a person responsible for their safety

## Warning

- Do not operate the UV-C emitter when it is removed from the appliance enclosure
- Read the maintenance instructions before opening the appliance
- The appliance must be disconnected from the supply before replacing the UV-C emitter

## Technical Specifications

Product	KENT Supreme
Product Code	111111
Product Generic Name	RO Water Purifier
Product Colour	White
Applications	Suitable for purification of Brackish/Tap Water/Municipal Water Supply
Weight	7.60 kg
Production Rate	20 L/hr.*
Body Material	ABS Food Grade Plastic
Mounting	Wall-mounting
Dimensions(mm)	400 (L) x 250 (W) x 525 (H)
Recovery Rating (Min.)	40%
Reject Water Generation (Max.)	60%
Maximum Operatable Feed Water TDS	1500 mg/liter
Filter Cartridge	Sediment Filter, Carbon Filter & UF Membrane
UV LED Wattage	0.7 W
Operating Pressure (Min./Max.)	0.0344 MPa - 0.3792 MPa
Operating pH (Min./Max.)	6.5-8.0
Storage Capacity	8 L
Maximum Duty Cycle	100 L/day
Membrane Type	Thin Film Composite RO
Booster Pump Voltage	24 V DC
Wattage	60 W
Power Supply	Single Phase 230 V AC, 50 Hz. 
IP Rating	IPX1

## Testing Information

The System has been tested according to IS 16240:2023 (Standards for drinking water as per Bureau of Indian Standards) for reduction of the hazardous substances.

## Performance Data Sheet KENT Supreme Mineral RO™ Water Purifier

"This system has been tested according to NSF/ANSI 58 for reduction of the substances listed below. The concentration of the indicated substances in water entering the system was reduced to a concentration less than or equal to the permissible limit for water leaving the system, as specified in NSF/ANSI 58".

Substance	Influent challenge concentration mg/L	Maximum permissible product water concentration mg/L	"Minimum % Reduction"
Total Dissolved Solids	750 ± 40 mg/L	187	86.80%

"Do not use with water that is microbiologically unsafe or of unknown quality w/o adequate disinfection before or after the system".

The replacement component, 200010 SP Inline Sediment Filter 8, 200009 SP Inline Carbon Filter 8, 200529 SP RO Membrane High Flow, 200015 SP Post Carbon Filter (Blue), 200003 SP Hollow Fibre Membrane, 202202 SP FRT 350, Can be purchased directly from the manufacturer KENT RO SYSTEMS LTD.